

INSTALLATION INSTRUCTIONS - WALL & WATER

Read the installation instructions all the way through and make sure that you understand the instructions completely before starting to install. Please also watch the installation video on www.berryalloc.com. If hidden corner profiles (HydroLoc) are to be used, follow also the instructions described in section J and/or if the wall height is over 240 cm, follow the instructions described in section I.

Before installation allow the BerryAlloc Wall&Water panels to acclimatize at room temperature with the packaging unopened for at least 48 hours (min. 72 hours when cold stored). The air humidity has to be more than 30 %, both during and after the installation. The wall panels are impermeable and functions as a membrane so you need to remove any damp barriers in exterior wall constructions.

A. Framework:

The BerryAlloc Wall&Water panels shall be installed on a framework with centre-to-centre vertical spacing of 600 mm and horizontal spacing of 800 mm. Make sure that the framework is perfectly in level (use laser tooling). NB: The distance from the corner to the first/last vertical stud on each wall section must not be longer than 580 mm, due to that the tongue or groove/locking profile needs to be cut off on those 2 panels.

Additional battens must be used if heavy objects are to be mounted on the wall panels.

When installing panels directly on an existing concrete or brick wall the studs should be laid flat against the wall or the panels glued directly to the solid wall (see separate instructions on www.berryalloc.com).

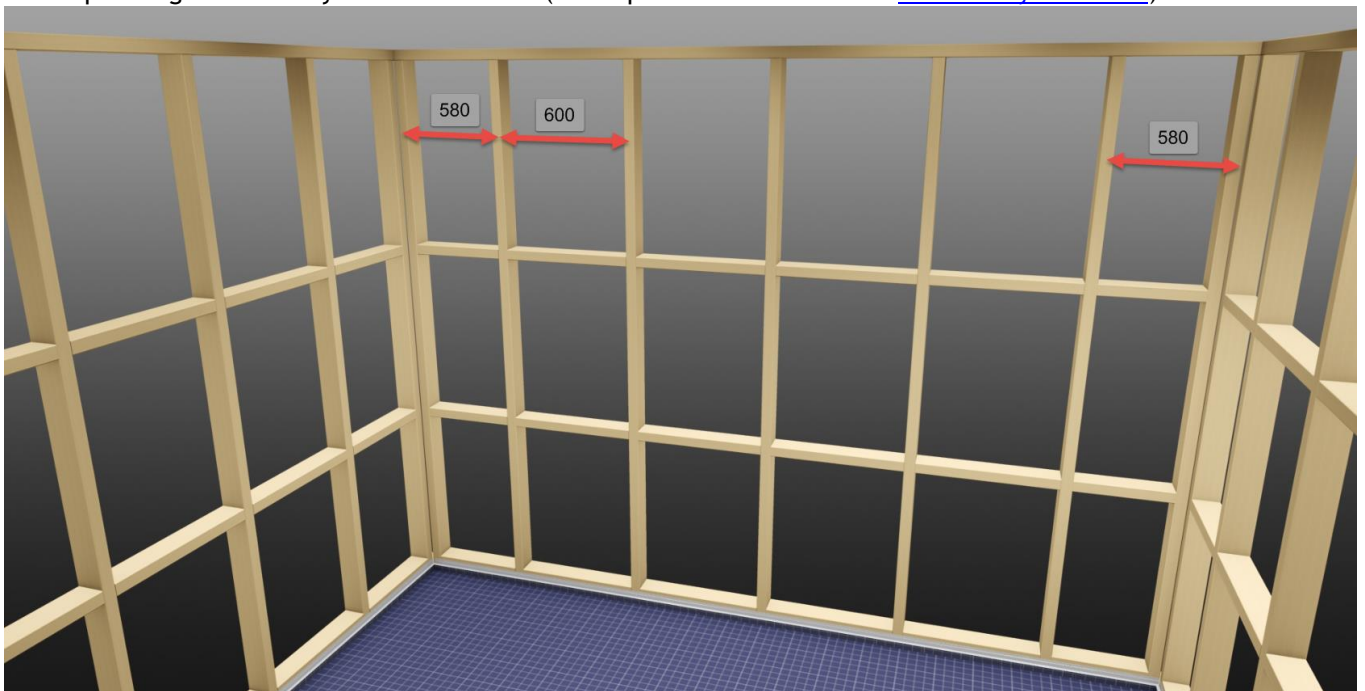

B. Required special equipment:

Corner profiles (QuadraLoc or HydroLoc), base profiles, BerryAlloc Sealant, BerryAlloc Wipes, BerryAlloc screws, BerryAlloc joint spatula (HydroLoc) and BerryAlloc tapping block (QuadraLoc). If other equipment (which is not described in this section and on www.berryalloc.com) is used, the warranty provided may no longer apply.

C. Fitting the base profiles:

Make sure that the base profiles are fastened perfectly in level on all wall sections, in order to prevent height differences between the panels (use laser tooling). Add sealant on the backside of the base profiles and fasten them with screws to the framework. Kindly see illustrations how the base profiles should connect in the corners. Recommended distance from the base profile to the floor covering is 60-80 mm. When raised tile edge is used you need to leave a distance of 3-5 mm between the tile edge and the base profile. This gap is to be sealed completely with sealant.

NB: The membrane must stick up min. 25 mm above the raised tile edge.

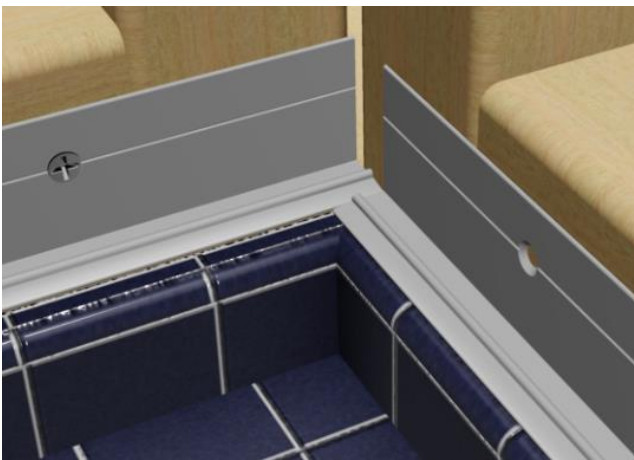
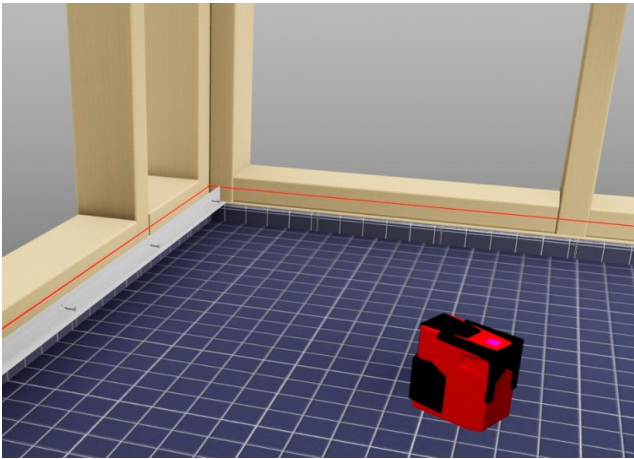

D. Fitting the inner corner profiles:

The inner corner profile (QuadraLoc) consists of two parts, internal profile and cover. The internal profile is to be fastened to the framework with screws. Make sure that the internal profile is fastened absolutely vertically. The cover will be pressed onto the internal profile after the whole installation is completed (section F).
NB: Leave a distance to the ceiling of min. 5 mm.



E. Installation of panels:

E1. Installing the first panel on the wall

Start installing to the right of any inner corner profile. Measure the distance in 3 places (top, middle and bottom) from the pin on the internal profile of the QuadraLoc corner profile to the center of the first vertical stud. Cut the panel (NB: Minimum the tongue on the left side of the panel has to be cut off).

Height adjustment of the panel is carried out to the ceiling. Skirting will conceal the gap (min. 5 mm).

Place the panel on the base profile and against the pin of the internal profile of the QuadraLoc corner profile. Make sure that the panel is positioned in level (use laser tooling) before you fasten the panel with screws to the framework. Use screws every 20 cm in the height of the panel (first screw 2 cm from the bottom of the panel).

NB: The head of the screw must not stick up otherwise it will prevent the next panel from being installed!

Remove the protecting foil before you continue with the next panel (for excluding any visual defects).

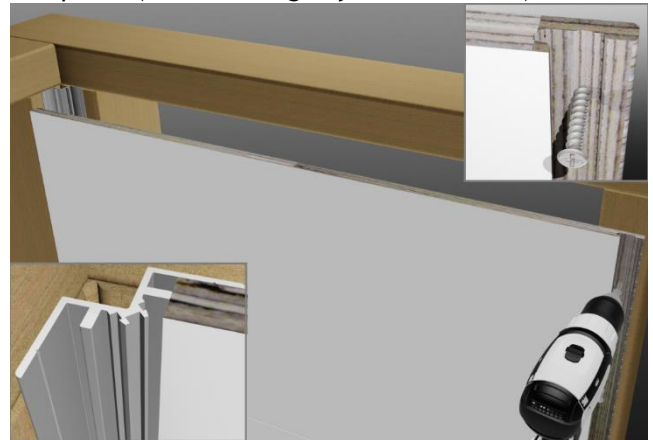
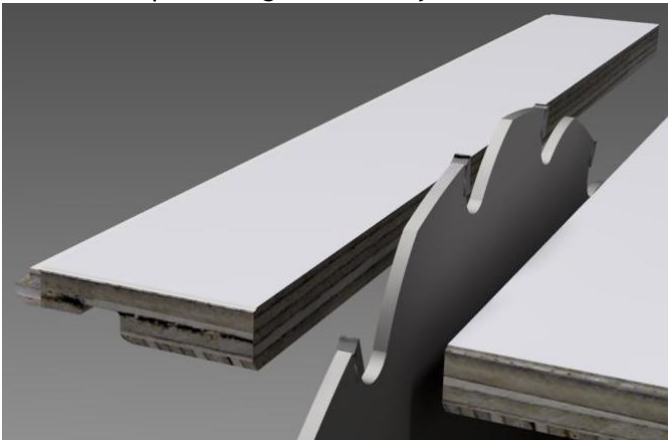

E2. Installing the next panel on the wall

Place the next panel into the locking profile of the previously installed panel. Click it in by placing your hand on the right side of the panel while you press it towards the framework. Fasten the panel with screws to the framework.

In wet zones the panel joints has to be sealed. Apply sealant on the tongue (left side) of the panel that is to be installed. The sealant shall be visible along the whole joint after the panel has been installed. Excess sealant is carefully removed with a plastic scraper and cleaned with BerryAlloc Wipes.

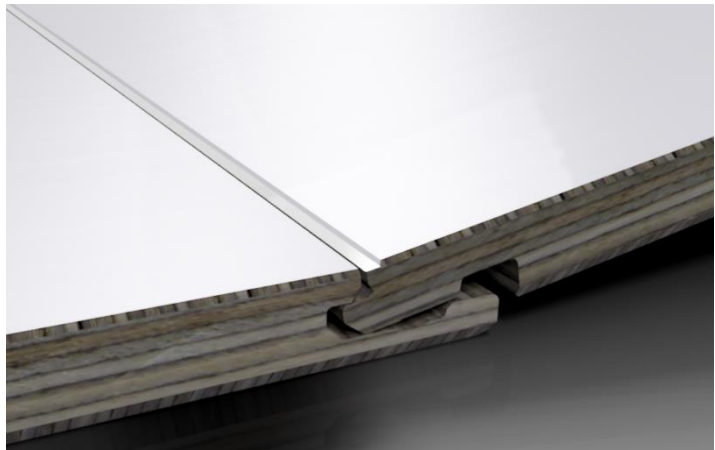
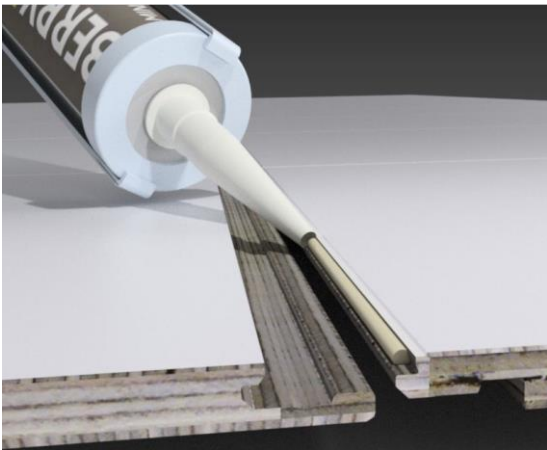

E3. Installing the final panel on a wall (ending with an inner corner profile)

Measure the distance in 3 places (top, middle and bottom) from the décor edge of the previously installed panel to the pin on the internal profile of the QuadraLoc corner profile. Cut the panel (NB: Minimum the locking profile on the right side of the panel has to be cut off). Install the panel (leave it unscrewed).

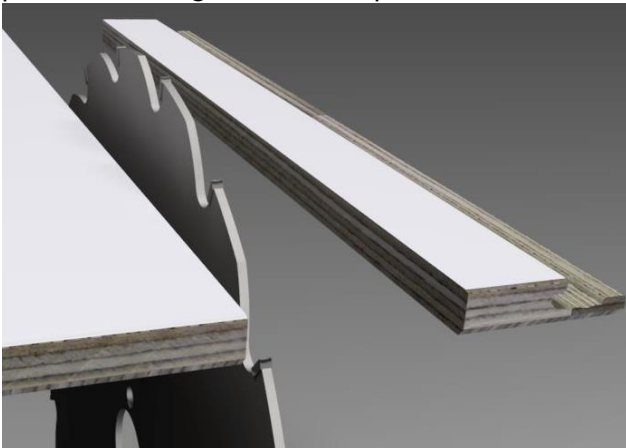

E4. Installing the final panel on a wall (ending with an outer corner profile)

Measure the distance in 3 places (top, middle and bottom) from the décor edge of the previously installed panel to the corner. Cut the panel (NB: Minimum the locking profile on the right side of the panel has to be cut off). Add sealant into the slot of the outer corner profile. Place the outer corner profile on the right edge of the panel. Install the final panel together with the outer corner profile. Fasten the outer corner profile with screws to the framework. NB: If the wall section has to be extended in height (see section I for more information) then the outer corner profile is not yet to be screwed.

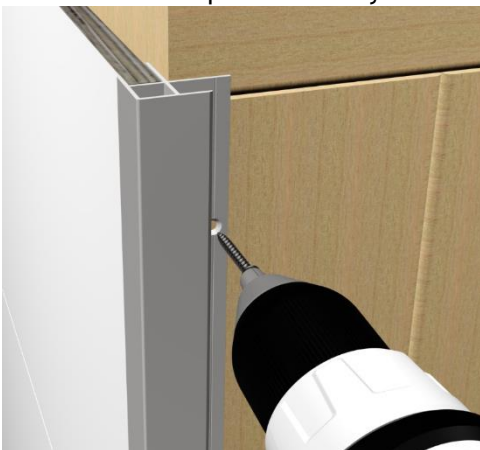

E5. Installing the first panel on the next wall (starting with an outer corner profile)

Measure the distance in 3 places (top, middle and bottom) from the inside of the slot of the outer corner profile to the center of the first vertical stud. Cut the panel (NB: Minimum the tongue on the left side of the panel has to be cut off). Add sealant into the slot of the outer corner profile. Place the panel on the base profile and into the slot of the outer corner profile. Make sure that the panel is positioned in level (use laser tooling) before you fasten the panel with screws to the framework.

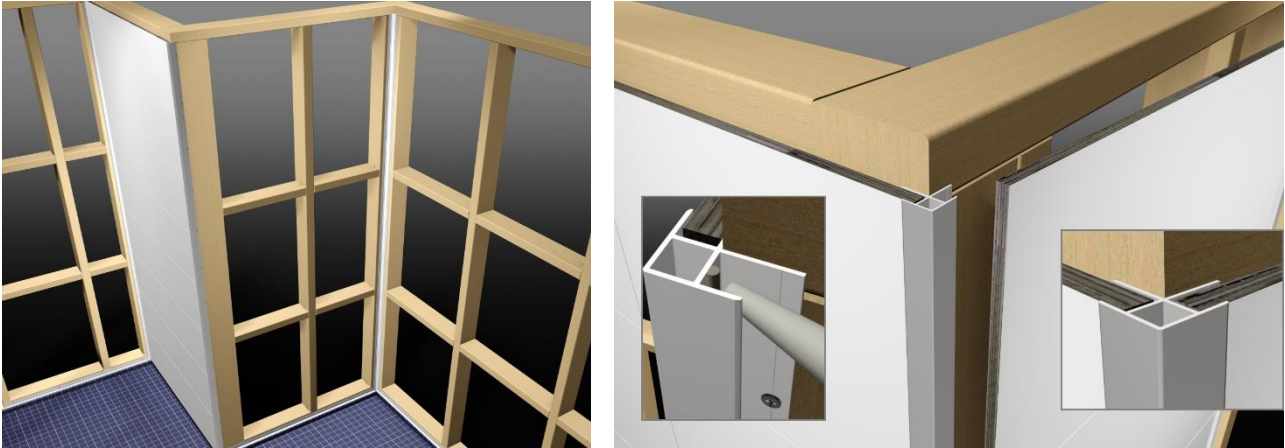

F. Fitting the cover of the inner corner profiles:

Add sealant on the backside of the cover (along both wings) and press the cover onto the locking groove of the internal profile of the QuadraLoc corner profile. Use the BerryAlloc tapping block and a hammer to make sure the cover locks properly. NB: The sealant will be visible along both edges of the cover if the cover is properly attached and sealed. Excess sealant is removed with a plastic scraper and cleaned with BerryAlloc Wipes.

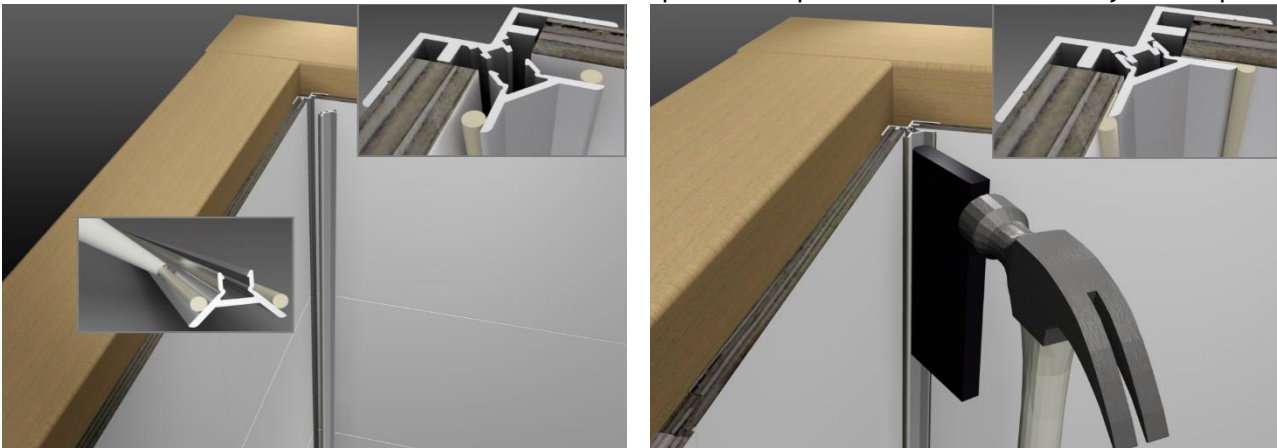

G. Sealing the panels and the base profiles:

Employ masking tape along the bottom of the panels. Fill the gap between the panels and the base profiles with sealant. Use a scraper/spatula to make the transmission between the panels and the base profiles smooth. Tear the masking tape off. Put sealant on your finger and add sealant in the area underneath where the base profiles and the corner profiles connect.



H. Holes for pipes and screws:

When holes for pipes are needed in the panels, these holes are to be done before installing the panels. Use a drill and adequate drilling cup with a diameter 10 mm larger than the pipe itself. Single pipes are secured by using sealant around the pipe. Wall mounted pipe boxes have a cuff that surrounds the box. This cuff should be sealed against the panel.

When screw holes are needed for mounting something on the wall panel you need first to drill a slightly smaller hole through the surface of the panel. Fill the hole with sealant and also add sealant on the backside of each screw head just before finishing the tightening procedure.



I. Extension in height; from 240 cm upwards:

When the wall exceeds the panel height (240 cm), an H-profile in combination with cut panels in correct height shall be used. This installation procedure is done right after a wall section has been finished. Make sure NOT to install the cover of the inner corner profile before the extension panels and H-profile have been installed.

Measure the total width of the previously installed wall panel section. For not coming in conflict with the internal profile of the QuadraLoc corner profiles kindly notice the needed cut-off area on the backside of the H-profile and the required distance between both ends of the H-profile and the internal profile of the QuadraLoc corner profiles (see illustrations). Apply sealant into the lower slot of the H-profile before placing it on top of the previously installed panels. Measure the needed height of the extension panels from inside the slot of the H-profile to the ceiling. NB: Remember to leave a distance to the ceiling of min. 5 mm.

Cut the first extension panel in the same width as the first installed panel below. Add sealant to the upper slot of the H-profile. Place the first extension panel into the slot, starting from the pin of the internal profile of the QuadraLoc corner profile. Make sure that the extension panel is positioned in level (use laser tooling) before you fasten the panel with screws to the framework.

For being able to install the next extension panel you need to position it just above the H-profile while placing it in the right side locking profile of the previously installed extension panel. Use, after having clicked it in, an angle iron (placed on top of the extension panel) and tap the extension panel gently downwards into the H-profile. Fasten the extension panel with screws to the framework.

Cut the final extension panel in the same width as the installed panel below. Install the final panel.

NB: When installing extension panels on a wall section which ends with an outer corner profile the outer corner profile is not to be fixed with screws to the framework until the final extension panel is installed.

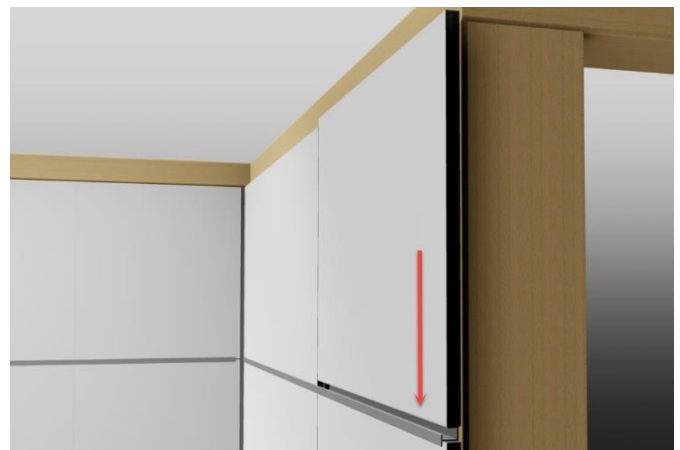
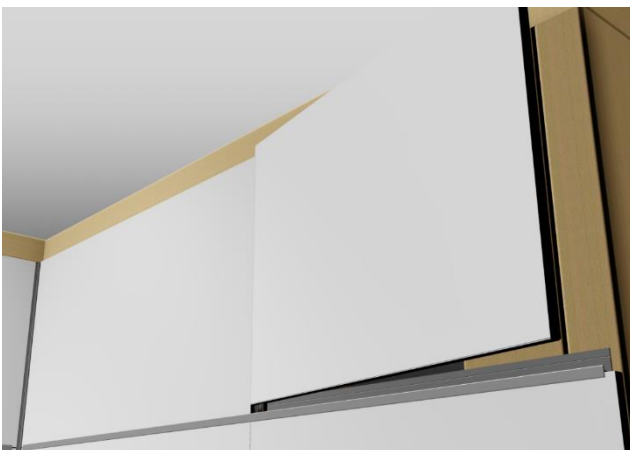
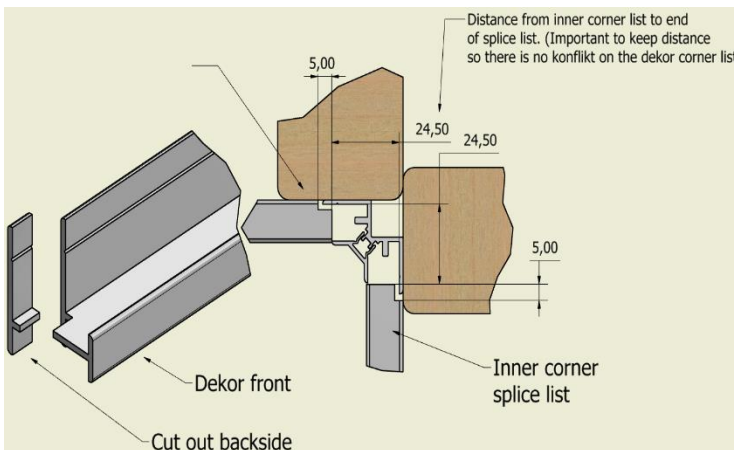
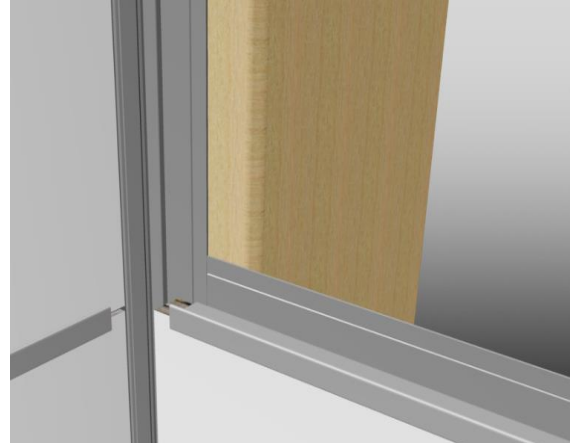
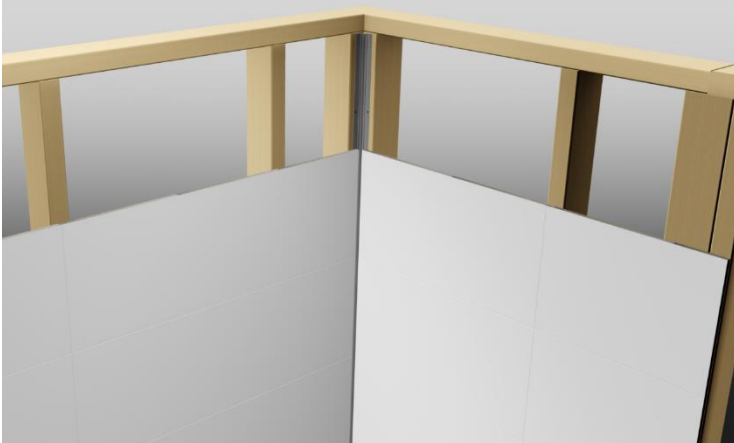

J. Installation of panels using hidden corners profiles (HydroLoc):

Plan the installation so that the final panel (uncut in its full width) will be installed above the door. It is therefore important that the dimensions/positions of the other panels on this final wall section are correct.
NB: Cut the panels by using a plunge cut saw with guide rails. For having a clean cut result on the surface start by making a very shallow cut in the surface before making the final cut. Use fine-tooth saw blades.

J1. Installing the first panel

Start the installation to the right of the door and proceed in clockwise direction. This is important with regard to completing the installation correct. Measure and cut the first panel in correct dimensions. Fasten the panel with screws to the framework. Make sure that the panel is installed in level (use laser tooling).



J2. Installing the next panel (see section E2)

J3. Installing the final panel on a wall (ending with an inner corner profile)

Measure the width of the last panel on the wall section. Measurements should be taken at least in 3 places (top, middle and bottom) to secure the right distance to the inner corner (remember to leave a gap of 2-4 mm between the installed panel and the inner corner). Cut the panel. Double-check the gap by positioning it in place. Remove the panel and add sealant on the right edge of the panel. Use the HydroLoc joint spatula to make the string of sealant even. Install the panel (leave it unscrewed).

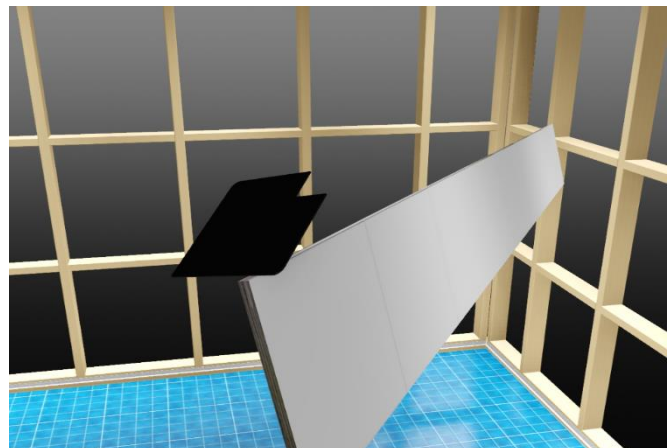
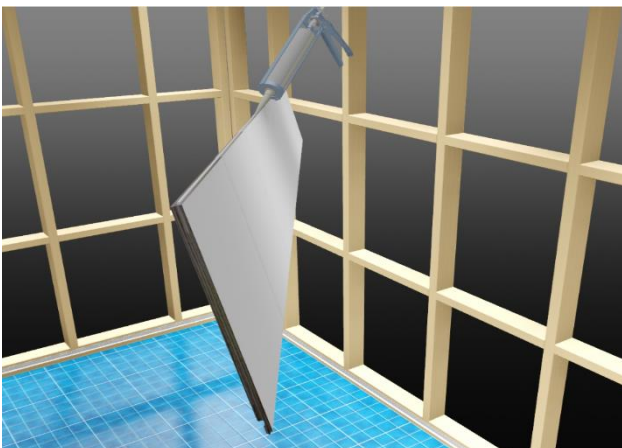
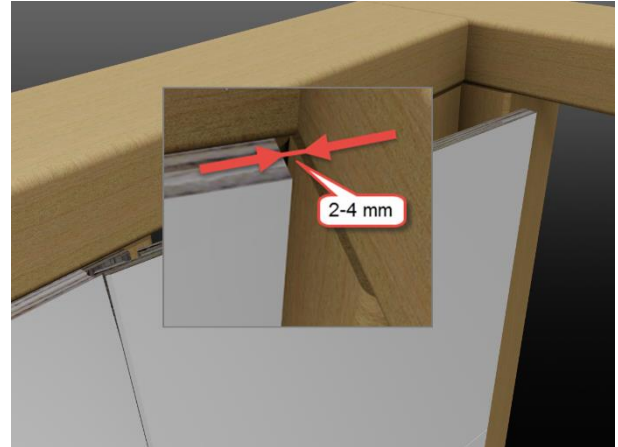

J4. Installing the first panel on the next wall (starting with an inner corner profile)

Measure the width of the first panel on the next wall section. Measurements should be taken at least in 3 places (top, middle and bottom) to secure the right distance to the center of the first vertical stud. Cut the panel and turn it around for installing the inner Hydroloc corner profile on the backside. Use HydroLoc screws and make sure that they are fitted straight and flat. Turn the panel (with the pre-installed Hydroloc profile) around and place it in the inner corner. Fasten the panel with screws to the framework. Make sure that the panel is installed in level (use laser tooling).

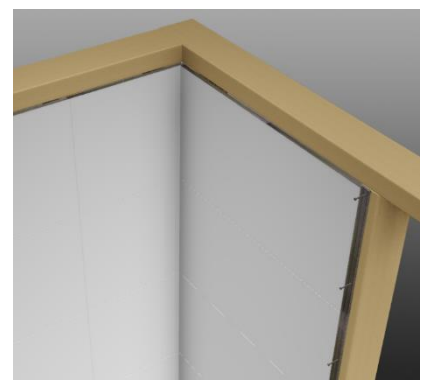
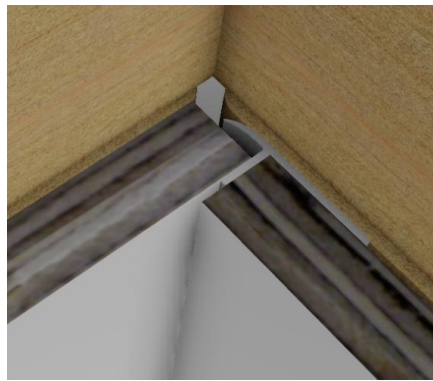
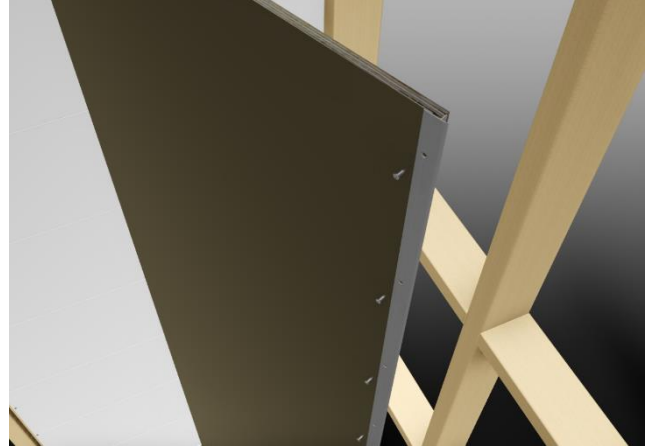
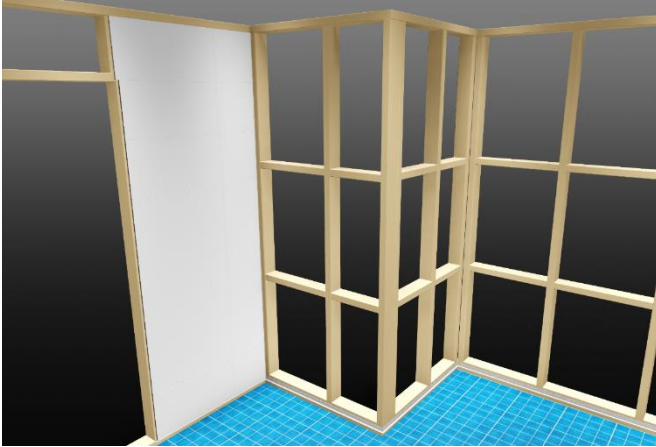

J5. Installing the final panel on a wall (ending with an outer corner profile)

Place the outer Hydroloc profile on the corner and measure the width of the final panel on the wall section. Measurements should be taken at least in 3 spots (top, middle and bottom) to secure the right distance between the décor edge on the previously installed panel and the marker on the outer corner profile (where the backside of the final panel should end). Cut the panel. The cut must be made in an angle of 45 degrees! NB: Sand the beveled edge lightly to make it less sharp. Turn the panel around and install the Hydroloc corner profile on the backside of the panel. Use HydroLoc screws and make sure that they are fitted straight and flat. Install the panel (with the pre-installed Hydroloc profile) and fasten the profile with screws to the framework.

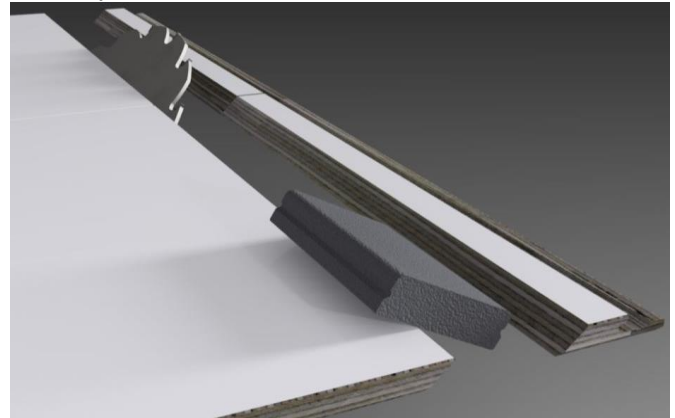
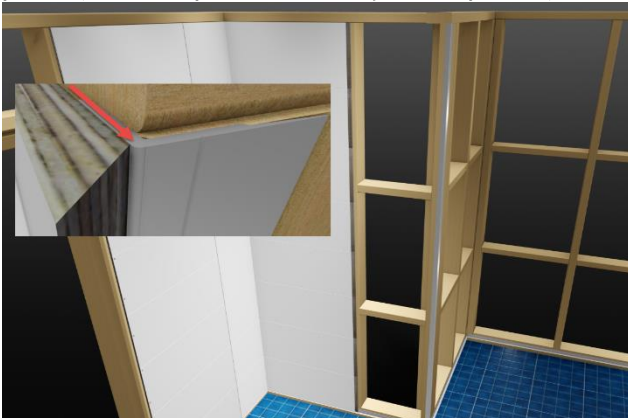



J6. Installing the first panel on the next wall (starting with an outer corner profile)

NB: At least 2 panels must be installed on this wall. Measure the width of the first panel on the next wall section. Measurements should be taken at least in 3 places (top, middle and bottom) to secure the right distance from the marker on the outer corner profile to the center of the first vertical stud. Cut the panel. The cut must be made in an angle of 45 degrees! NB: Sand the beveled edge lightly to make it less sharp! Turn the panel around and install the locking profile of the external Hydroloc corner profile on the backside of the panel. NB: The distance between the edge of the panel and the profile must be 40 mm! Use HydroLoc screws and make sure that they are fitted straight and flat. Add a small amount of sealant along the edge of the panel. Take the panel (with the pre-installed locking profile) and slide it into place. Fasten the panel with screws to the framework.

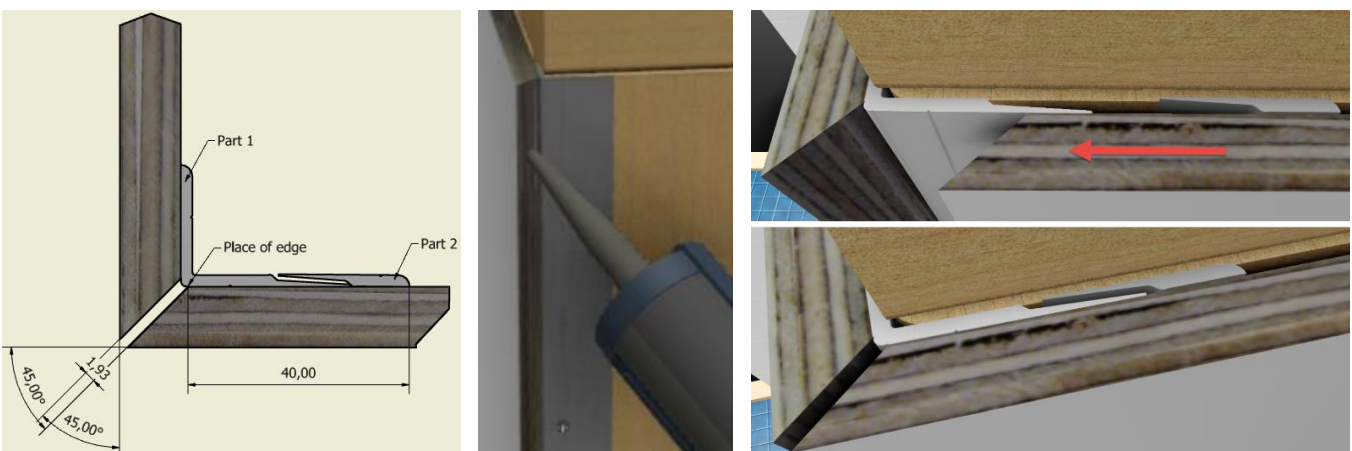
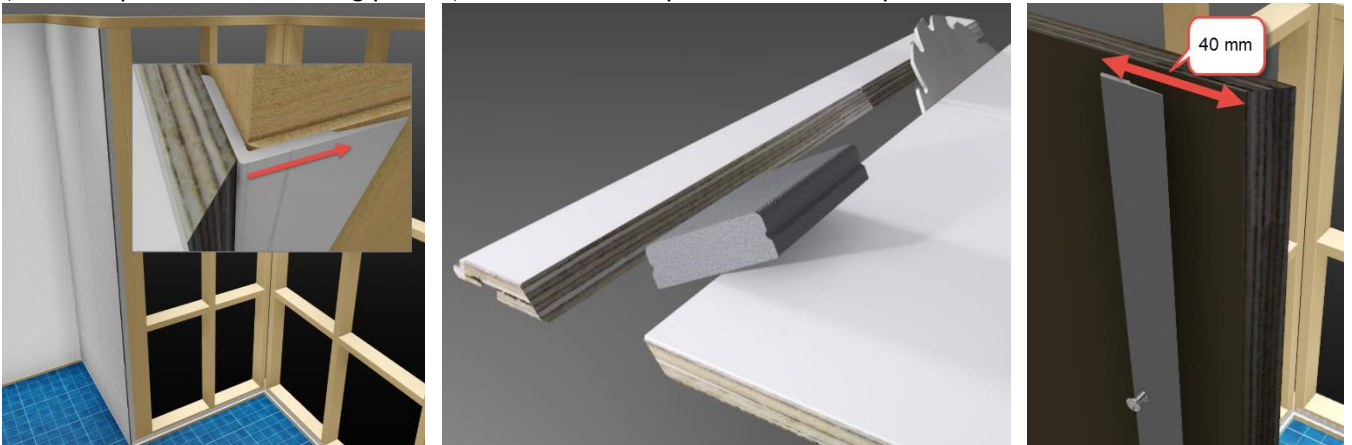

J7. Installation of the final panel (above the door)

Make sure to end the installation with a panel in full width (600 mm). For making the installation of the final panel (above the door) easier, we recommend that the locking profile on this panel is cut off. Take the modified panel and slide it upwards into the tongue and groove of the previously installed panels. Fasten the panel with screws. Door and ceiling skirting will cover the screw heads.



J8. Sealing the corners

Employ masking tape along all corner panels (NB: On inner corners the tape is placed approx. 1,5 mm from the corner on each corner panel). Add sealant between the tapes in the inner corner. Fill the gap between the panels in outer corners with sealant. Use the HydroLoc joint spatula to make the transmission between the panels smooth. Try to do this in one long movement for best result. Tear the masking tape off. Do not make contact with the sealant until it is dry!

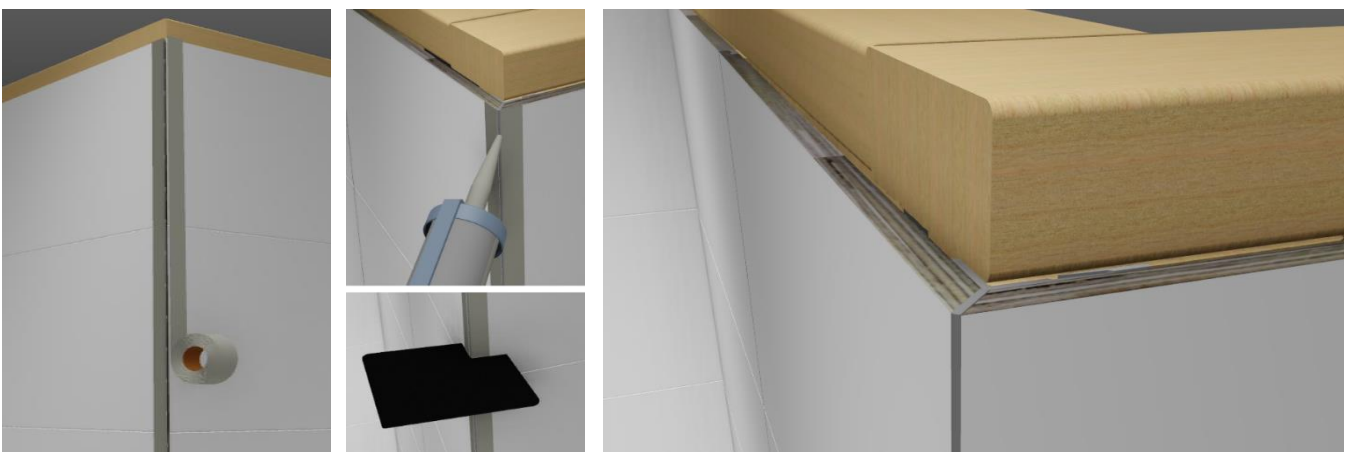
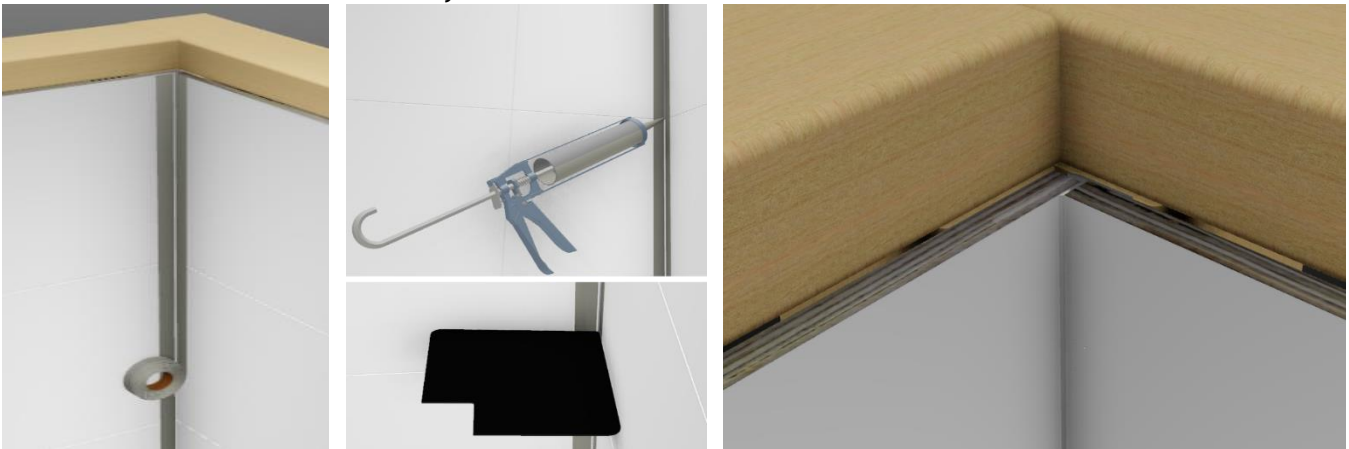

J9. Sealing the panels and the base profiles (see section G)

BERRY ALLOC

Cutting panels - achieve a smooth finish:

Plunge cut saw/Miter saw - decorative side up Use a steady support and/or guide rails when cutting
Jigsaw/circular saw - decorative side down Use a steady support when cutting
Hand saw - decorative side up Put pressure when sawing downward.

STORAGE, HANDLING, CLEANING AND MAINTENANCE:

- BerryAlloc Wall&Water shall be protected from rain or snow during transport or storage.
- BerryAlloc Wall&Water shall be stored horizontally, dry and on a leveled surface, with the decorative surfaces towards each other in order to prevent unnecessary damages to the surface.
- Lift the panels apart from each other in order to avoid scratches on the decorative surface.
- Uncured sealant is easily and most securely removed with BerryAlloc Wipes.
- Cured sealant shall be removed with a plastic scraper and cleaned afterwards with White spirit.
- Clean the surface of BerryAlloc Wall&Water at a regular frequency with a cloth or a soft sponge with lukewarm water with a thin concentration of synthetic detergent. Otherwise maintenance-free.

